

THE SNR EXPERT DIAGNOSIS:
ANALYSIS AND RECOMMENDATIONS
FOR OPTIMIZING BEARING LIFE.

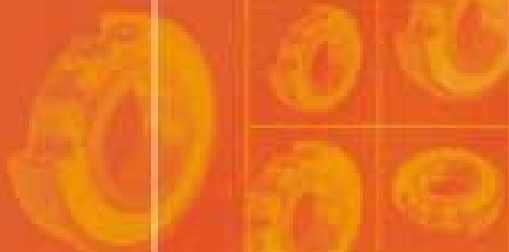

The SNR Expert Diagnosis: Analysis and Recommendations for Optimizing Bearing Life.

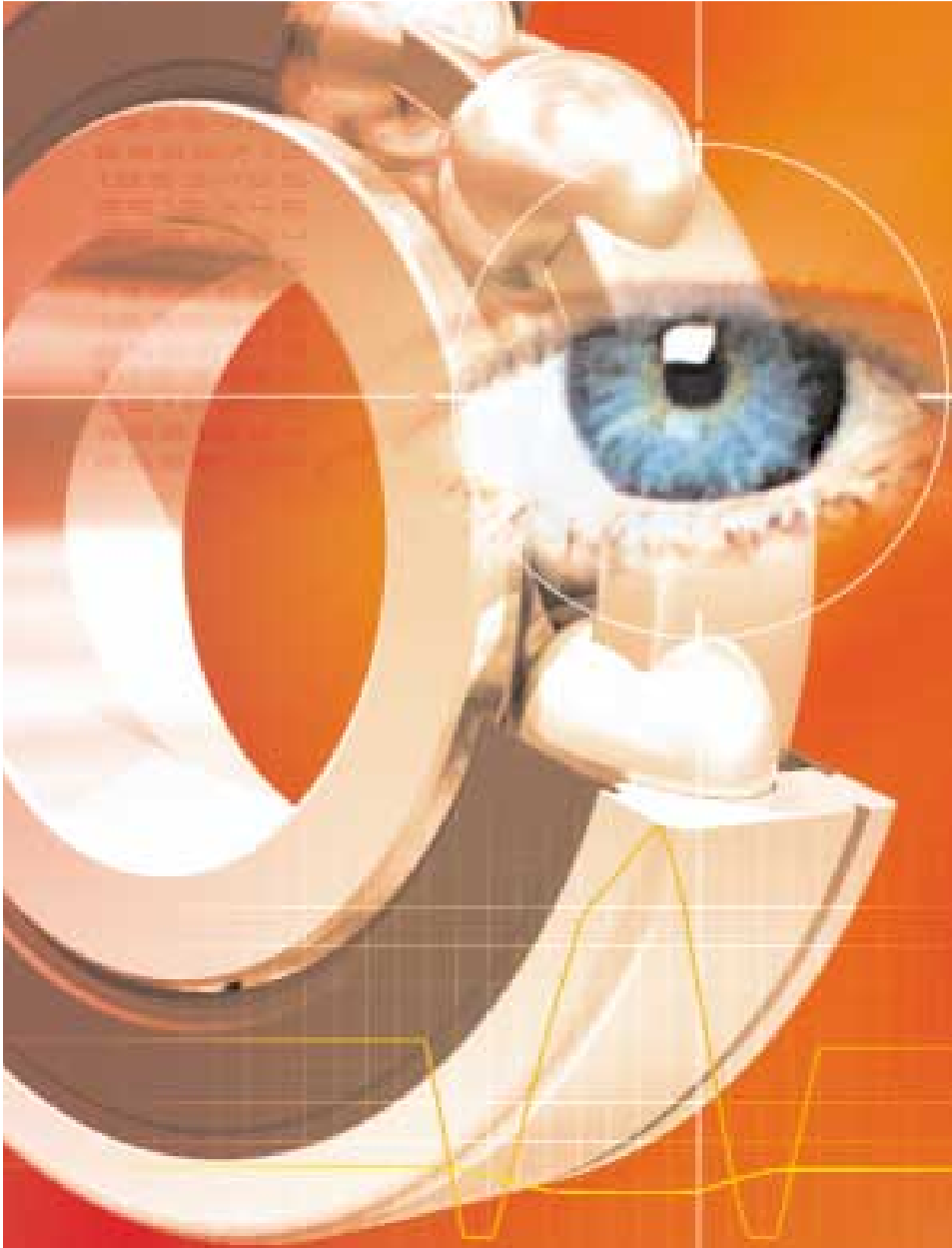

SNR - Industry



How to recognize failures?

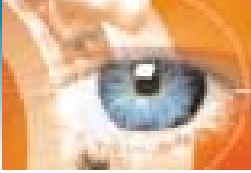

Appearance of suspect bearings

The appearance of a bearing is a key indicator of its health. Common failures include spalling, seizing, rolling element indentations, vibrations, wearing, foreign matter indentations, pitting and flutings, shock load marks, nicks, cracks, fractures, metal-to-metal contact corrosion, corrosion, and cage failures. Each failure is identified with a number that corresponds to the section where the failure is described.

1 Spalling



5 Wearing -
Foreign matter
indentations



2 Seizing

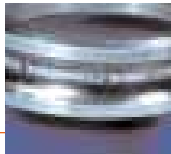

6 Pitting and
Flutings



3 Rolling element
indentations on
raceways due
to distortion or
metal flaking



7 Shock load
marks - Nicks -
Cracks -
Fractures



4 Vibrations



8 Metal-to-metal
contact
corrosion



9 Corrosion

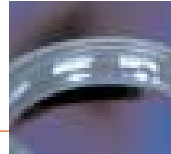

10 Cage
failures

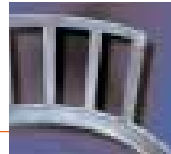

Note: Discoloration is the eleventh failure identified by our technical experts. Relatively rare and infrequently detected in service, it is not discussed in this document.

How can a malfunction be diagnosed rapidly?

The left-hand column of this table lists the “warning signs” that may be observed on the bearings (after disassembly and assessment). The right-hand column gives you an initial idea of the probable causes of the malfunction. For further information and to refine your diagnosis, refer to the following pages, where the sections are classified by malfunction.

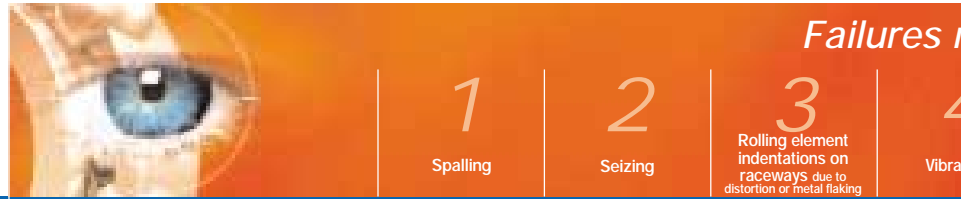

		Failures				
		1 Spalling	2 Seizing	3 Rolling element indentations on raceways due to distortion or metal flaking	4 Vibrations	
Origin of failures or defects	Mounting factors					
	• Improper handling				Q	
	• Shocks				Q	
	• Improper housings or seats		Q	Q		
	• Fit too tight		Q	Q		
	• Fit too loose					
	• Misalignment		Q			
	Operating factors					
	• Radial overload		Q			
	• Axial overload		Q	Q		
	• Vibrations					Q
	• Excessive speed			Q		
	Environmental factors					
	• Temperature too low					
	• Temperature too high			Q		
	• Electric arcing					Q
	• Water etching		Q			
	• Dust and dirt					
	Lubrication factors					
	• Improper lubricant		Q			
• Lack of lubricant		Q	Q			
• Excess of lubricant			Q			

Discoloration is the eleventh failure identified by our technical experts. Origin of the damage or defects: fit too tight (fitting), axial overload and

Malfunctions detected in service



Vibration



Temperature Increase



Noise



Friction Torque

registered after removing the bearing

4	5	6	7	8	9	10
ations	Wearing - Foreign matter indentations	Pitting and Flutings	Shock load marks - Nicks - Cracks - Fractures	Metal-to-metal contact corrosion	Corrosion	Cage failures
	Q		Q			
			Q			Q
						Q
						Q
				Q		
						Q
	Q					Q
						Q
						Q
		Q				Q
					Q	
	Q					
						Q
						Q

excessive speed (operation), temperature too high (environment), excess lubricant (lubrication).

Table of contents

Introduction

To be forewarned is to be forearmed	p.2
---	-----

Why does a failure occur?

How to detect failures, and how to identify them?	p.4
Classification of bearing failure causes	
Causes and origins of bearing environmental failures	
How to detect the beginning of failures?	p.5-6
External indications of damage	
Interpretation of external indications	
Preventive control procedures and tools	
Failure identification: methods and procedures	p.7
What is the procedure?	

Analysis of actual cases

1. Spalling	p.8-13
2. Seizing	p.14-15
3. Rolling element indentations on raceways due to distortion or metal flaking ...	p.16-17
4. Vibrations	p.18-19
5. Wearing - Foreign matter indentations	p.20
6. Pitting and flutings	p.21
7. Shock load marks - Nicks - Cracks - Fractures	p.22-23
8. Metal-to-metal contact corrosion	p.24
9. Corrosion	p.25
10. Cage failures	p.26-27
Consequences of improper location of load areas	p.28-31

Introduction

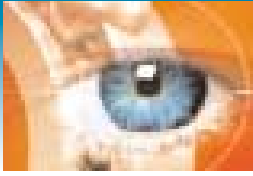

To be forewarned is to be forearmed

This document is made for all people who might face the challenge of a bearing failure, but particularly to those who want to prevent it. As a bearing is often a "concealed" component, the detection and prevention of its failure demand thorough knowledge of its structure, its stresses and the external signs likely to indicate a failure.

There is no such thing as an everlasting bearing

*No matter how perfect its geometry, no matter how advanced its material, **a bearing has a limited life expectancy.***

This life duration varies from one bearing to another, and results from statistical computation, which our Engineering offices determine for each application.

Different bearings are not "programmed" for the same lifetime, depending on their operating conditions, the complexity of replacing them and the consequences of their failures.

It is essential to consider these points before discussing "failure".

Wear and fatigue: two concepts that must not be confused



*If the life of a bearing is compared with that of a human being, **fatigue failure** can be considered to be a "**natural death**", a normal occurrence: having been subjected to the loads and stresses for which it was designed, the bearing must be replaced within a time conforming to its specification. There is no failure, but rather fatigue.*

SNR test centers measure this fatigue using statistical distributions to calculate the probable lifetime of a bearing.

*However, life of a bearing may be shortened suddenly. **An event, often of external origin, causes damage. This is the type of problem that we discuss here.** Just like a disease, abnormal wear of a bearing can develop slowly or suddenly. It also exhibits symptoms, more or less easy to detect.*

The strength of experience

*A bearing is thus a "living" component, for which "prevention is better than cure". **Accurate and early diagnosis of a failure will prevent it becoming more severe**, and can also be used to predict the same type of problem with other bearings, before they exhibit the same symptoms.*

*In designing millions of bearings intended for all types of application, SNR Engineering has acquired an extensive experience. **We want to share this expertise with you today. It enables you to maximize the benefit from our products, optimize their maintenance, and thus enhance performance.***

Why does a failure occur?

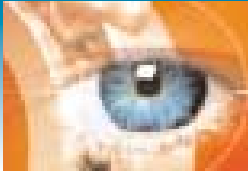

How to detect failures, and how to identify them?

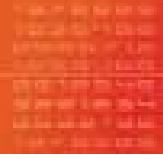

Classification of bearing failure causes

Failures can be classified in 3 major categories:

- Failures due to **environmental factors**: improper or negligent mounting, dirty working conditions, inadequate lubrication, over-loading, vibrations, excessive speed, overheating, pollution...
- Failures due to a **misapplication**: inadequate size or type of bearing, or improper installation process.
- Failures due to the **quality of the bearing** itself: improper steel or defect in its structure, problems of internal geometry, cage quality, seals, etc.
- Failures can occur following the use of **inappropriate fitting tools**.

This guide will only outline the **environmental factors that cause 90% of bearing failures**. Failures mentioned in category 2 concern Engineering Departments. Failures mentioned in category 3 seldom occur.

Moreover their investigation and analysis require elaborate means of research and quality control.

Causes and origins of bearing environmental failures

The following causes of failures are the most common. Bearing failures usually stem from many reasons but all causes can be classified in 4 basic categories:

1. A properly-fitted bearing is a bearing that lasts

- Improper tools and mounting procedures.
- Unclean mounting conditions.
- Inatallation shock loads.
- Improper manufacturing of components surrounding the bearing: out-of-tolerance shafts and housings, inadequate lubricant supply, misalignment.

2. A necessity: conform to the specifications

- Over-loading.
- Vibrations in an operating or static bearing.
- Excessive speed.
- Shaft deflection (bending).

3. The environment is critical

- Too low or too high an ambient temperature.
- Electric arcing.
- Contamination from water, dust, chemical product, textile debris...

4. Lubrication is an integral part of the bearing

- Improper lubricant.
- Inadequate supply of lubricant.
- Relubrication frequency.

The chart in the fold-over cover sums up the basic failures with their corresponding causes and will guide the user in identifying the probable origin of failures.

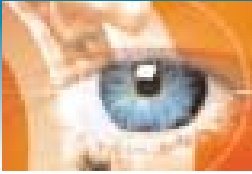

How to detect the beginning of failures?

The main concern for the user is to detect the beginning of a failure before the equipment or machine breaks down.

Preventive maintenance is certainly the best remedy but is cost effective in certain cases only. Often, reaching the bearings involves extensive and skilled labor, long downtime and high expenses.

In a few cases, preventive maintenance is a "must" (aircraft industry, mine ventilation...). More

frequently the bearing damage will have to be identified from **an external indication**.

The amount of fatigue in a bearing might be difficult to evaluate from external indications. **Generally the bearing is close to the end of its useful life when the external indications are detectable.**

External indications of damage

A bearing rotating under functional conditions will exhibit certain "normal" operating **levels of temperature, noise and vibrations**.

Exact levels will vary, as they are dependent on several factors: **load, speed, lubrication, type of bearing**..

These levels should be considered as **signals or warnings** when they exceed those established for the "normal" or steady state conditions.

Deviations from the "norms" established under your operating conditions should signal the need for implementation of your preventive maintenance program or at least a close check to determine the cause of the deviation.

These signals are:

1. Vibrations

These can be detected by hand or with electronic equipment (frequency or amplitude analyzer). This type of equipment can be used to alert the operator or to stop the machine.

2. Noises

Some abnormal noises can be heard immediately,

such as those due to rolling element indentations because of improper mounting; others are progressive.

Noise is usually an indication of incipient failure and varies in intensity and frequency with the extent of the damage. Conversely the damage due to unbalanced loads is generally inaudible since their frequency is identical to the rotating assembly frequency.

3. Temperature rise

Any operating bearing is subjected to a temperature rise above the ambient. This rise depends on many factors and reaches a certain level considered as normal, for a particular mounting. Any rise beyond that normal level is an indication of failure.

4. Increase of the friction torque

Any rotation system (shaft, wheel, pulley...) presents a resistant torque, even when mounted on bearings. Any torque increase is indicative of an alteration in the bearing.

Generally, an increase of the friction torque generates a temperature rise.

Why does a failure occur?

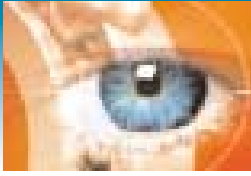

How to detect the beginning of failures?

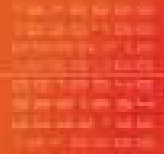

Interpretation of external indications



1. Vibrations

Spalling
Abrasive wear - foreign particles
Corrosion
Unbalanced loads due to bearing wear
Excessive clearance
Excessive loose fit of a ring...



2. Noises

Rolling element indentations
Spalling
False brinelling (indentations caused by vibrations)
Foreign particles
Corrosion
Elimination of the internal clearance due to excessive press fit
Cage or rolling element failure...



3. Temperature rise

Excess or lack of lubricant
Elimination of the internal clearance
Axial and radial overload, unintentional or due to improper mounting
Excessive speed...



4. Abnormal friction torque

Cage distortion
Lubricant deterioration
Seal damage or displacement
Elimination of radial play...

Each of these pictograms corresponds to an easily identifiable symptom (premature failure). You will see them again in the actual examples that follow.

Preventive control procedures and tools

How frequent should inspections be?

It essentially depends upon the expected reliability, on the material usage, and on many other factors specific to each user. **Sampling controls based on the bearing life expectancy should be regularly performed.**

Beyond visual inspection, can specific devices be used?

These tools are very limited. However, some control equipment detecting unusual vibrations are available. "Sonic meters" measuring the bearing noise level can also be used.

In any case, a "reference level" should be established in order to measure variations.

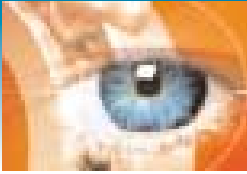

Failure identification: methods and procedures

It is often difficult to identify failures.

The following steps should be considered:

- Record all **significant facts noticeable on the bearing**.
- Record any noticeable symptoms on components surrounding the bearing.
- Identify all probable failure causes.
- Among these possible causes, **select those matching the majority of the signs**.

What is the procedure?

Carefully examine the bearing and note any characteristics such as:

Before removal:

- Contamination
- Condition of the lubricant
- Temperature
- Loss of lubricant
- Noise
- Torque
- Evolution of deterioration
- Position of the bearing in the assembly

After removal:

Never clean a bearing before examination. Doing so would prevent the search and identification of foreign particles as well as the review of the condition and quality of the lubricant.

- Note the condition of cages and rolling elements.
- Keep track of bearing and ring mounting location.
- Check shaft and housing fits.
- Check the abutments: out of squareness, presence of residue, metal-to-metal contact corrosion...

Analysis of actual cases

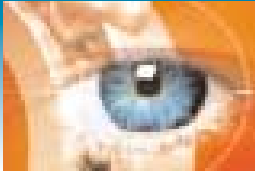

1 Spalling: Origin - appearance



Spalling can be found on raceways as well as rolling elements. It can be deep (fatigue spalling), or shallow. In both cases, causes and symptoms are different.

Fatigue spalling



Shocks on outer ring raceway

As outlined in the introduction, a bearing has a limited life expectancy. The operating loads to which it is subjected determine its fatigue life. When the correct bearing is used and it is mounted properly, **the result of this fatigue is spalling - which seldom occurs within the bearing normal life span.**

Only spalling which has contributed to repetitive early failures will be studied here.

Spalling fatigue mechanism

When a bearing is subjected to loads, pressures in the race-way-rolling element contact area can be very high. Shearing forces are developed with a maximum value occurring at some thousandths of an inch below the contact surface. These repetitive stresses, caused by the continuous traveling of the rolling elements, initiate the spalling.

Small **cracks in the material** start at the high stress point and progress to the surface. These cracks will join and cause **the metal to flake away**, in a rapidly expanding area.

Spalling aspects

Spalling is a progressive phenomenon that increases more or less rapidly after the appearance of the first cracks. Consequently, the material spalling must be detected at its early stages since it will result in a premature failure.

Some spalling appearances are described hereafter to assist you in identifying the damage stage.

Spalling



Vibration



Noise



Temperature Increase



Friction Torque



Fatigue spalling

Beginning of spalling

Some jointless fractures appear on the surface. The surface finish is damaged. The component profile has not changed but the cracks are characteristic of an underlying fatigue.

Advanced spalling

The fractures tend to join. The component profile has not changed but the surface finish is badly damaged, indicative of an advanced stage of fatigue. Some metal chips flake away, get mixed with the lubricant and accelerate the destruction.

Final spalling

The whole surface is spalled. Metal alterations due to shearing are now joined. The spalling destroys the component profile and the bearing can no longer operate properly.

Shallow spalling



Surface spalling due to too low a viscosity

This failure is characterized by the appearance of **grayish marks of varying extent on the raceway surfaces and in the load zone**. A microscopic examination will show that the metal is only superficially affected.

Where does this problem come from?

Inadequate (insufficient, improper) lubrication for the application is at the origin of this type of failure. The oil film may break down under the pressure due to the load applied on the bearing, and would then allow the surface of the rolling elements and raceways to come in contact. The micro-weldings initiated under the load, would cause thin and superficial metal flaking. This is not a material fatigue but a damage affecting the surface only.

Analysis of actual cases

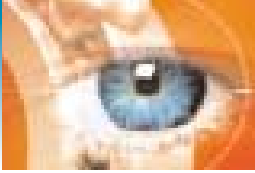

1 Spall location

1. Introduction
2. Spall location
3. Load zone
4. How can it be identified?
5. Where does this problem come from?
6. How can it be avoided?

It is essential to locate the spalling accurately in order to analyze its causes and find an appropriate solution.

Load zone



How can it be identified?

Spalling located in the load zone affects most of the width of a roller bearing raceway, the bottom of a deep-groove ball bearing race, and both raceways of a double row ball or roller bearing.

Where does this problem come from?

The bearing is subjected to transient or continuous overloads.
The lubrication is inappropriate or insufficient.

How can it be avoided?

- Check bearing loads.
- Use an adequate supply of a proper lubricant.

Edge of raceway



Cone spalling due to misalignment

How can it be avoided?

- Carefully check the shaft and housing alignment.
- Keep housings clean as some misalignments are due to the presence of foreign matter between the bearing faces and their contact shoulders.

How can it be identified?

For ball bearings, the ball path runs from one side of the race to the other around the non-rotating ring. The rotating ring has a ball path wider than usual.

Cage fractures might occur in certain cases.

For tapered or cylindrical roller bearings, fatigue areas can be detected on the edge of the raceways, or on a single raceway for double row roller bearings. The contact areas vary from one race edge to the other on both rings, and are diametrically opposed on each ring.

Where does this problem come from?

These failures are due to **shaft and housing misalignment initiated** either by an improper parallelism between the shaft and the housing-bore centerlines, or a lateral runout of the housing or shaft shoulders.

The above can also be observed from a shaft deflecting while operating.

These faulty parts generate a concentration of unintentional excessive stresses on the bearing and the latter develops premature fatigue failures in these overloaded areas.

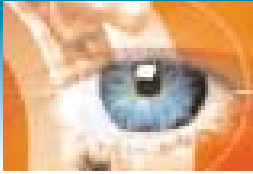

1 Spall location

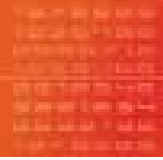

On non-rotating ring: entire raceways



Raceway overloaded

How can it be avoided?

- Control shaft grinding tolerances.
- When mounting spherical roller bearings on tapered adapter sleeves, make sure to use a feeler gage to assure proper internal clearance after mounting.

We advise you to use the SNR slide rule provided for this purpose.

How can it be identified?

Severe abrasion or spalling of the raceways is observed over their entire circumference, even in the area opposite the load zone on the ring that is stationary with respect to the direction of the load.

Where does this problem come from?

Generally, the ring rotating with respect to the direction of the load should be mounted with a press fit. The fit tightness is dependent on the application requirements. The heavier the load, the tighter the fit. This is meant to prevent the rings from rotating on the shaft or in the housing. An excessive interference fit can reduce or eliminate the internal clearance of the bearing and cause a preload to develop in addition to the normal operating loads. Then all the rolling elements are in contact with the raceways.

In addition to premature spalling, an **excessive interference** fit might generate internal stresses in the rings. These unusual stresses, added to the Hertz pressures due to the load, can generate cracks and even ring fractures (re. Chap. 7).

Driving a tapered bore self-aligning ball or spherical roller bearing too far up a tapered adapter sleeve would incur the bearing distress described above.

This action over expands the inner ring, first reducing then eliminating the internal clearance and dangerously preloading the bearing.

On non-rotating ring: particular areas



Damage caused by a geometric defect of the housing



Cone spalling due to taper of the shaft or housing

How can it be identified?

When examining the non-rotating ring:

- **Intensive raceway spalling or highly visible ball or roller path** in two diametrically opposed areas, sometimes in several areas of the ring.
- **Spalling extended all around the circumference of the raceway.** However the location on one edge shows that only this area has been working.

Where does this problem come from?

The defects triggering these types of failures are different from those already mentioned (lateral runout of housing shoulders). In that case it is a **housing distortion**.

In the first case the distortion comes from an out of round condition in the housing (elliptical or triangular). The outer ring will follow the housing shape resulting in visible evidence of excessive load, in the areas corresponding to the squeezing. This fault can be identified on self-aligning ball bearing rings mounted in cast iron or steel housing units. It can also be the result of foreign particles in the housing, which will locally distort the ring.

In the second case the damage is characteristic of a tapered housing. One ring edge only is stressed. For tapered or cylindrical roller bearings, spalls are located in the highest squeezed area of the ring. For self-aligning ball or roller bearings, only one row of rolling elements is running with overstresses.

Spalling located on this raceway can also be identified and even fractures of ring edge can develop "longitudinally" because of high Hertz pressures. Similar faults on inner rings are extremely rare as the distortion amplitude of shafts is not high enough to produce that type of damage.

How can it be avoided?

- Machine the housings only when material is heat stabilized.
- Along with the dimensional check, perform a housing geometrical check to detect any distortion (roundness, off taper).

Analysis of actual cases

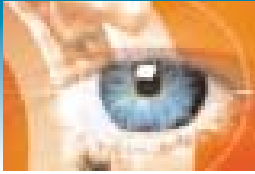

2 Seizing

Seizing is a failure mode of a bearing that occurs when the rolling elements and raceways weld together due to excessive heat or friction. This is often caused by inadequate lubrication, excessive preloading, or misalignment. The result is a complete loss of motion and potential damage to the bearing and shaft.

Seizing with ball imbedding



Damage to the flange due to excess preload



Seizing



Vibration



Noise



Temperature Increase



Friction Torque

How can it be identified?

Shallow metal flaking and the appearance of dark areas are significant of a superficial transfer of the metal.

Original grind or hone marks have completely disappeared in those areas. Brown patterns reveal local or generalized overheating; the rolling elements are strongly distorted by metal flaking, local melting and scoring, indicating a more severe condition.

Note: For tapered roller bearings, seizing frequently occurs between the cone back face rib and the large roller end.

Cages are partially or totally destroyed and sometimes their pockets are worn due to sliding contact of the rolling elements.

In the final stage, the overheating of the rolling elements on the raceways causes the bearing rolling elements to weld altogether.

Where does this problem come from?

Inadequate lubricant generates seizing of the bearing. Improper or under lubrication can result in the rupture of the oil film. Metal-to-metal contact takes place between rolling elements and raceways. Micro-welding and local overheating occur. This phenomenon will increase rapidly and generate seizing.

Note: Seizing of tapered roller bearings may happen under an excessive preloading condition (thrust overload) or if the lubricant is inappropriate or insufficient; it will primarily affect the large roller end and the cone back face rib. This type of damage occurs frequently when starting up new equipment if specific precautions are not taken to supply the bearing with sufficient or adequate lubricant.

If the bearing fitting tolerances on the seats are too loose, the shaft might rotate in the bore, or the outer ring might rotate in the housing. This causes an **overheating** that could generate seizing of the bearing components. Cracks might also appear.

Seizing of a tapered roller bearing with roller imbedding



Seizing of a spherical roller bearing with roller imbedding and flange fracture



Cage damage due to incipient seizing

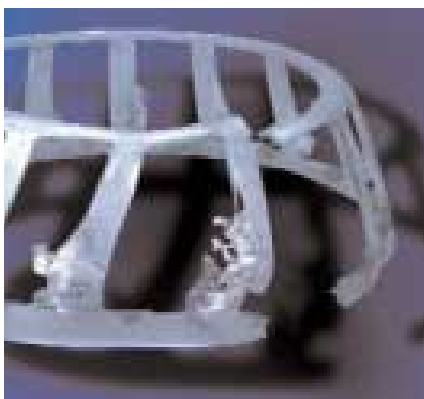

High speeds can also generate seizing when the bearing load is light. Rolling elements may not rotate instantaneously, either because of their inertia, or because of a rotational slow down caused by the lubricant. Friction generates a **temperature rise** and the resulting expansion causes seizing between rolling elements and raceways.

This damage can also occur under a pure radial load if an excessively high viscosity lubricant is used. In roller bearings, the speed of the rollers that are not in the load zone decreases. The rollers tend to skid, which may cause an overheating.

How can it be avoided?

- Carefully follow lubrication advice provided by the Equipment Manufacturer, Lubricant Supplier, or our Engineering Department.
- Use an adequate lubricant for the application.

The lubricant should be carefully selected so that it always provide an oil film between the rolling elements and the raceways in the contact areas. Its selection as well as the definition of lubrication process must take the characteristics of the contact surface, loads, speeds, and operating temperatures into account. Consult our Engineering Department.

Special care has to be taken in greasing tapered roller bearings. Lubricant must be introduced under the cage, towards the large end of rollers, prior to operating newly mounted equipment.

When very high speed is involved, a lubricant allowing a prompt rotation of rolling elements should be used. In some instances a light preload might be required.

Analysis of actual cases

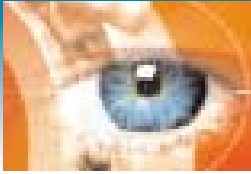

3 Rolling element indentations on raceways due to distortion or metal flaking

Ball bearings



due to fitting the shaft by driving the outer ring

How can it be identified?

In ball bearings, **indentations generally have a tapered shape and affect especially the edge of the raceway**. They are located either all around the perimeter of the raceways or on a more or less extended area. They are spaced corresponding to the ball spacing. **The bottom of the dent is shiny but marks of original grind can be found.**

Where does this problem come from?

This is the most common damage resulting from improper mounting. It occurs when a **shock or a force is exerted on the ring that is not press-fitted and is then transmitted to the other ring through the balls**. If the shock generates an instantaneous load, which exceeds the known material elasticity limit, ball-to-raceway contact zones are permanently dented. These dents cause an abnormal noise and initiate future spalling.

Two major causes of shock loads:

- Mounting the bearing by hitting one ring with a hammer to install the opposite ring.
- Dropping the bearing on a hard surface.

How can it be avoided?

When mounting a bearing ring with a tight fit, **force should not be exerted on the other ring**. If the tight fit ring is difficult to reach, it will have to be press-driven with a tubular sleeve with proper shoulder diameter, squareness, and appropriate length.

To avoid accidentally dropping the bearing, work in clean, uncluttered areas whenever possible.

Rolling element indentations on raceways due to distortion or metal flaking



Vibration



Noise



Temperature Increase



Friction Torque

Cylindrical roller bearings



Material tears on the outer ring raceway

How can it be identified?

Raceways show deep scratches, **more or less evenly spread**, perpendicular to the ring faces, along with **metal pick up marks**, and spaced corresponding to the roller spacing.

Where does this problem come from?

Forced Assembly

The small radial clearance between the diameter over (or under) the rollers and the raceway diameter of the opposite ring might cause these two

components to jam when assembling them. When this jamming occurs, mounting pressure or shock load generates scratches on the raceway of the opposite ring.

How can it be avoided?

Never force one ring into another.

When setting up a shaft with an installed inner ring, it is recommended to rotate this shaft while mounting it into the outer ring. This rotation will help the rollers to be properly located, preventing their jamming. It will be the same for an outer ring mounted into a gearbox casing for instance.

It is recommended to **grease** the bearing thoroughly **before assembling**; lack of grease promotes bearing jamming and seizing.

Tapered roller bearings



Spalling in the middle of the rolling element path

Mounting shocks.

Dents might develop if cone is used to install the cup in its housing.

Analysis of actual cases

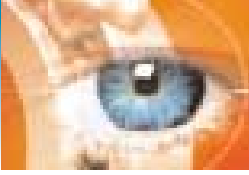

4 Vibrations

1. 2. 3. 4. 5. 6. 7. 8. 9. 10. 11. 12. 13. 14. 15. 16. 17. 18. 19. 20. 21. 22. 23. 24. 25. 26. 27. 28. 29. 30. 31. 32. 33. 34. 35. 36. 37. 38. 39. 40. 41. 42. 43. 44. 45. 46. 47. 48. 49. 50. 51. 52. 53. 54. 55. 56. 57. 58. 59. 60. 61. 62. 63. 64. 65. 66. 67. 68. 69. 70. 71. 72. 73. 74. 75. 76. 77. 78. 79. 80. 81. 82. 83. 84. 85. 86. 87. 88. 89. 90. 91. 92. 93. 94. 95. 96. 97. 98. 99. 100.







False brinelling on a ball bearing

How can it be identified?

On raceways, the bearing rings show **dark or shiny indentations - more or less spread out** - spaced corresponding to the rolling element spacing. The presence of several dents, being superimposed or located in between, can be seen at times. However, rolling element spacing is always noticeable on dents. Through a microscope, indentations appear to be caused by a total removal rather than a back flow of material as it occurs when shock loads are applied. In all cases, grinding marks have disappeared. **This failure is also referred to as "false brinelling".**

Vibrations

-  Vibration
-  Noise
-  Temperature Increase
-  Friction Torque



False brinelling on a roller bearing

Where does this problem come from?

False brinelling is **always caused by vibrations** or other small amplitude oscillatory motion of the rolling elements between the raceways in a stationary bearing. However, it can also affect a bearing in operation, when both rings rotate simultaneously in total synchronism (ex. pilot bearings). Failure mechanism can be described as follows:

Under both pressure and vibrations, the lubricant is forced out of the loading area causing metal-to-metal contact between rolling elements and raceways. Vibration stresses generate micro-welding or micro-seizing and eventually flaking of metal chips. Oxide will impregnate those particles as in contact corrosion, and their abrasive power will accelerate the phenomenon.

This type of failure can be found:

- On bearings mounted on machines which are not operating but are subjected to intensive vibrations.

- On rotating bearings when both rings rotate at the same speed and consequently remain stationary one in relation with the other.

This type of failure can appear on emergency electrical generators connected to the same platform as an operating generator, on non-running electrical motors mounted on rotating machines, on emergency fans connected with operating fans, when transporting unbraced equipment or machines subjected to vibrations...

The heavier the equipment, the more intense the vibrations, and the greater the risk to the bearings.

How can it be avoided?

- When transporting engines, generators, or similar equipment, block up their shafts.
- The periodic rotation, even slowly, of a stationary machine in a vibration area will allow the lubricant to spread out and prevent the loads from being exerted on the same spot of the raceways.
- Large sized bearings should be stocked in a flat position and out of vibration area (work shops).
- For infrequently operated machinery, it is recommended to use low viscosity lubricants, more capable of impregnating the contact-to-contact surfaces than a high viscosity lubricants.
- For operating machinery:
 - Low viscosity greases (NLGI grade) are more efficient. Silicone-base grease are among the least effective.
 - The best resistance to false brinelling is obtained with low-viscosity base oils.

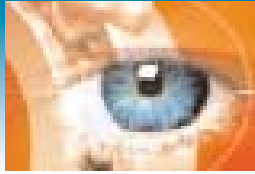

5 Wearing - Foreign matter indentations



Corrosion and wear when rotating (liquid ingress with relubrication)

How can it be identified?

- **More or less intense development of a visible load path** on raceways and rolling elements; raceways might show a continuous or discrete longitudinal groove.
- **Excess clearance, unbalanced loads and vibrations** might occur.
- **Cage wearing.**
- Small **dents** on the ring path, with slightly rounded edges, characteristic of material deflection.
- Bearing life expectancy is abnormally reduced due to speedy **material fatigue**.
- Abnormal **noise**

Where does this problem come from?

All these failures come from a **lack of protection**, either **when mounting or when operating the bearing**. Frequently the user does not realize how destructive dust can be for bearings. Regardless of its origin or texture, **dust has a very high abrasive power**, and with time, results in excessive internal clearance and unbalanced loads which increase the rate of material fatigue. The cages are subjected to more or less severe wearing.

Foreign matter indentations have the same origin as wearing. Faulty protection lets foreign particles penetrate the bearing. These particles, constantly interfering between rolling elements and raceways, will initiate a multitude of small indentations

that will make the bearing noisy. The deterioration of raceway and rolling element surface finish will accelerate the material fatigue.

This fact has been clearly identified by our test laboratories.

How can it be avoided?

- When mounting bearings, **clean shafts** and housings and use dust free working areas.
- Do not clean new bearings.
- Protect bearings from dust when stocking.
- Use clean lubricants. Cover lubricant containers when not in use.
- Wrap any mechanical parts that are waiting for installation.
- Accordingly prevent ingress of any kind of debris (textile, straws, fibers...) or dust (coal, sand, metal chips, chemical products...) into the bearing.
- Whenever possible, use sealed or shielded bearings or SNR special reinforced sealing to provide extra protection against contamination.

Wearing - Foreign matter indentations



Vibration



Noise



Temperature Increase



Friction Torque

6 Pitting and flutings



Electric current through the rotating inner ring



Electric arcing on the inner ring



Pitting with dark bottoms on the rolling elements

How can it be identified?

- **Pitting:** Microscopic examination shows **pits with sharp edges** joined in a string. Pitting indicates a local metal melting.
- **Fluting:** A sequence of **narrow transverse grooves**, which look like splines, following one another in the raceway zone subjected to load. They can also appear on rollers.

Where does this problem come from?

This failure might occur on rotating machines, such as machine tools, railroad equipment, engines, etc., when **the bearing is crossed by an electric current leakage and is the only link with the ground.**

• High amperage current:

Because of the short distance between raceways and rolling elements, arcing will arise (even through lubricant) and produce high temperature spots where the metal melts.

• Low amperage current:

It results in the emergence of intermittent surface alterations, which show up as gray discolorations on rotation.

How can it be avoided?

- Be sure the **machinery, including all parts in motion, are grounded.**
- Check insulation, clean electric motor collectors to prevent current leakage.

Pitting and fluting



Vibration



Noise



Temperature Increase



Friction Torque

Analysis of actual cases

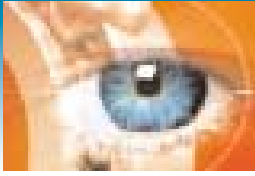

7 Shock load marks - Nicks - Cracks - Fractures

Careless hammering during mounting is the cause of these types of failures.

Shocks - Nicks - Cracks - Fractures

Fractures due to force-fit assembly



How can it be identified?

- **Shock load and tool marks** marks on flat surfaces, rolling elements and radii.
- **Nicks and fractures** of shoulders and ribs.

Where does this problem come from?

If a shock load, to which a ring is directly subjected, exceeds the metal elasticity limits, it will produce a permanent dent. **Shocks** can generate different problems: ring distortion, indentations.

In some cases, **shocks** can cause nicks, cracks, or even fractures. Cracks are very insidious for they may not be easily visible at first but they gradually produce metal chips, which make their way into the bearing and deteriorate raceways and rolling elements.

Cylindrical roller bearings are frequently affected by these failures, since the roller guiding shoulders are particularly sensitive to shocks. Several cases of fractures can appear on spherical roller bearings. When the outer ring swivels, one or several rollers can be dislocated in their cage pockets. Putting them back is rather difficult since, once dislocated, the rollers tend to wedge in between the external face of

Shock load marks - Nicks - Cracks - Fractures



Vibration



Noise



Temperature Increase



Friction Torque

the outer ring and one shoulder of the inner ring. When the rollers are dislocated, any shock load on the outer ring to force it to swivel back will be transmitted by the rollers to the shoulder of the inner ring.

Fractures occur frequently and **their spacing corresponds to the exact roller spacing.**

How can it be avoided?

No shock load should be exerted on the rings or their shoulders by hammering. When mounting, use a tubular sleeve - with the same diameter as the ring to be fitted - between the hammer and the bearing. This sleeve will spread the shock forces all around the circumference of the ring. To carry out this operation easily, SNR provides you with a fitting kit containing all the appropriate tools.

*Note: When press-fitting tapered, cylindrical, or spherical **roller bearings on a shaft**, the inner ring should be expanded by heating in an approved method.*

In most cases and depending on the diameter of the bearing, heating to 180°F or 190°F generates enough ring expansion for an effortless fitting.

To relocate the swiveled outer ring of a spherical roller bearing, carefully rotate the ring while realigning the dislocated rollers. Do not use force to close the bearing.

Ring fracture

How can it be identified?

- **Fractures** affecting large areas of the ring.
- **Transverse fractures.**

Where does this problem come from?

- **Housing distortion.**
- **Outer rings: overloads** resulting from an internal preloading caused by the elimination of the internal clearance due to excessive press fitting of the inner ring on the shaft (Re. Chap. 1 Spalling). Heavy radial stresses may result in multiple fractures of the ring.
- **Transverse fractures of inner rings:** metal overstressed from **excessive interference fit.**

How can it be avoided?

Check that fitting tolerances do not result in the elimination of internal clearance and consequently in preloading the bearing. If heavy press fit is required, use a bearing with an increased internal clearance.

Analysis of actual cases

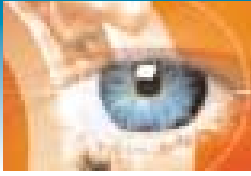

8 Metal-to-metal contact corrosion

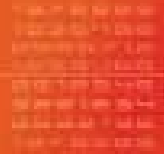

Contact corrosion in the bore and the abutment face

How can it be identified?

The origin of these failures is quite similar to the false brinelling (Re. Chap. 4).

These phenomena are located in the bore, on the outside diameter or faces of bearings. **Pink, brown or black marks** appear. Microscopic examination shows a more or less deep attack of the surfaces. **When rubbed, these spots leave rusty marks.** When damage is more severe, rings and raceways are coated with a brown paste resulting from the mixture of rust and lubricant. If the corrosion is deep, thin rings can break under load.

Where does this problem come from?

An interference fit is required for rings that rotate with respect to the direction of the load to prevent creeping.

If the **fit is insufficient** or non-existent, the shaft or the outer ring will creep slowly in relation to respectively the inner ring or the housing. This metal-to-metal motion will pick up thin metal flakes from the bearing and the shaft (or the housing) and cause local seizing. These particles will oxidize rapidly since lubricant is not present in

that area. Their abrasive power tends to accelerate the process; high surface roughness of the housing bores, which are not always ground, will facilitate its development.

When **the bearings rotate or vibrate on their seats**, contact corrosion will also appear on the bearing faces. This can happen when axial clamping is insufficient or if it loosens due to a shim collapse or to a locknut release. The corresponding bearing face will exhibit the hollow wear mark of the shoulder or locknut abutment.

How can it be avoided?

- **Control the geometry and fitting tolerances of shafts and housings** to provide the bearing with adequate press fit.
- **Check proper tightness** of lock nuts or housing end caps when they are essential to the bearing setting.
- In maintenance, eventually re-work the shaft.

Metal-to-metal contact corrosion



Vibration



Noise



Temperature Increase



Friction Torque

9 Corrosion

Corrosion when non-operating (liquid ingress)



Corrosion when operating (liquid ingress)



housing expands and leaks out. When stopped, with a return to ambient temperature, humid air flows back and condenses on the bearing. The repetition of this cycle generates deposits of an increasing quantity of water, which mixes with grease and does not totally disappear during the re-heating stage. Progressively, corrosion spreads to all internal components. The results are similar to those of abrasive dust. Oxides break off under the rolling element loads and these particles accelerate the abrasion. The presence of corroded spots is definitively significant of this type of failure. They affect every part of the bearing, including raceways, rolling elements as well as faces, bore, outside diameter and cage.

How can it be avoided?

- Use adequate shields or seals or improve present means of protection.
- Renew the ambient air with appropriate ventilation.
- Avoid projection of liquid on seals and shields that are not reinforced.
- Use a lubricant that does not emulsify with water.
- Use SNR special sealed bearings.

How can it be identified?

- Local or total **oxidation** of the bearing.
- Reddish or black spots with corresponding **surface deterioration or cavity** formation.

Where does this problem come from?

Introduction of corrosive liquid, or humidity, damaging the steel. **Faulty sealing of the assembly.** Corrosion can be systematic when a bearing operates in a very damp atmosphere and is subjected to frequent "on and off" operating cycles which are long enough to permit the temperature to decrease to the ambient value. When operating, the temperature of a bearing rises, the air in the

Corrosion



Vibration



Noise



Temperature Increase



Friction Torque

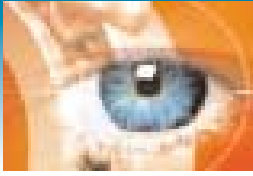

10 Cage failures

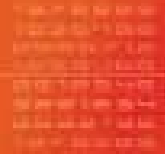

Distortion during fitting



Cage fracture due to vibrations

How can it be identified?

Distortion of cages - crushed cage pockets - shock load marks. These types of failures are quite difficult to identify as sometimes they are hidden by side effects: overheating, cage scoring due to rolling element friction, seizing.

Where does this problem come from?

The cage is highly vulnerable when the bearing is exposed on a workbench and during mounting.

Careless mounting can seriously damage the cage.

For instance, a ball bearing cage is very fragile as it is nearly flush with the ring faces and is thereby susceptible to mounting tool damage. A tapered roller bearing cage protrudes beyond the cone front face.

Cages can be damaged during installation if improper tools or no tool are used. When the bearings are mounted by hammering through drifts, these tools may trip, and distort or crush the cage pockets, thereby jamming the corresponding rolling elements.

How can it be avoided?

- Use a press for bearing installation whenever possible.
- Avoid the use of drifts.

When hammering cannot be avoided (for replacement essentially), use tubular sleeves with the same shoulder diameter as the ring to be fitted. This procedure is highly recommended for press fitting a cone, when the fitting force must be applied on its small face as the cage protrudes beyond this face.

Cage failures



Vibration



Noise



Temperature Increase



Friction Torque

Wearing

How can it be identified?

More or less severe wearing of cage pockets and inside and outside diameters of the cage.

Where does this problem come from?

Abrasive particles might make their way into the bearing at installation but more frequently during operation. **Radial overload** may also cause cage wear. For ball bearings, abrasion enlarges the cage pockets. The ball guided cage increases its clearance and becomes more and more unbalanced. Subsequently, the outside diameter of the cage rubs against the outer ring and its inside diameter against the inner ring. An unbalanced cage will increase the pocket wearing.

For tapered roller bearings, wear of the cage web, and sometimes cage fracture, might occur.

How can it be avoided?

- Carefully clean bearing seats and housings to eliminate any abrasive particles.
- Replace worn or damaged seals.
- If necessary, use special, more efficient SNR seals for ball or tapered roller bearings.
- Use clean lubricants and keep them clean by covering the containers when not in use.

Fracture

How can it be identified?

Fractures with or without scoring under rolling elements.

Where does this problem come from?

Cage fractures can originate from:

- Severe **damage when mounting**.
- **Vibrations** that generate shock loads
- Seizing due to **improper lubrication**.
- **Sudden accelerations or decelerations** generating cage pocket distortion.
- **Excessive cage speed** (ball bearings).
- Elimination of the internal clearance due to **too-tight a press fit** or too-large the temperature difference between the inner and outer rings.
- **Alternating and repetitive over-turning moments** on ball bearings. The constant change of the direction of the ball motion due to these over-turning moments, and the differential speeds between the balls cause repetitive pulling stresses on the cages, and will fatigue the metal and result in fractures.

- Housing distortion, uncontrolled unbalanced loads, etc....

How can it be avoided?

- **Avoid cage damage** during mounting.
- Use **proper lubricant** for the application requirements (speed, temperature, loads). Check that sufficient lubricant flow goes through the bearing.
- Control accelerations and decelerations.
- Check maximum speeds reached by the bearing and see that its design is adequate for those speeds.
- Check fitting tolerances and operating temperature.
- If there are alternating over-turning moments, use an **adequate type of cage** (consult our Engineers).

Analysis of actual cases

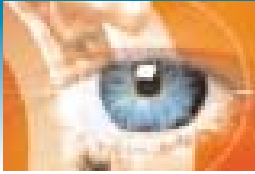

Consequences of improper location of load areas

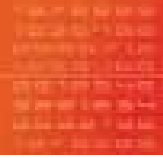

Misalignment

The examination of a bearing, even without failure, can show an operating abnormality due: either to a distortion of shafts and housings, or to an incorrect position of the bearing on its seat, or to a change of the normal operating conditions which the bearing was designed for.

Examination of rolling element paths on the raceways, which are visible even after a short operating time, enables one to determine whether they conform to those that are expected to appear, given the value and direction of the loads applied to the bearing.

If the rolling element paths do not correspond to those expected, then it means that the bearing was subjected to unexpected abnormal loads or distortions.

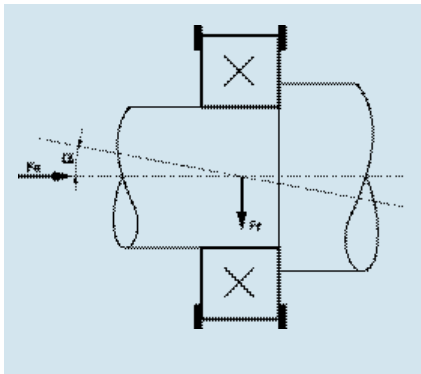

Legend

OR: Outer ring

IR: Inner ring

Stationary or Rotating: related to the loads.

Fr: Radial load

Fa: Axial load

a : Angle between bearing and housing-bore centerlines

Case # 1

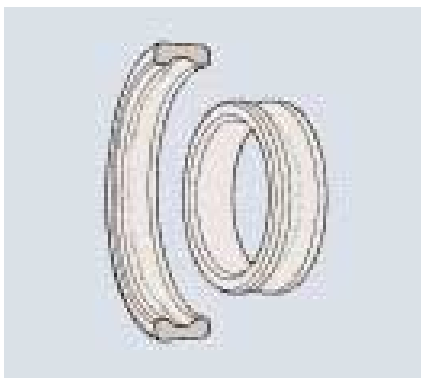

| | |
|-----------|---------------------------------------|
| OR | Stationary but creeps under load |
| IR | Rotates |
| Fr | Stationary in relation to the housing |
| Fa | None |
| a | None |

Identification:

Ball path can be seen all around the circumference of both raceways. Friction marks on the outside diameter.

Causes:

Abnormal rotation of the **OR** with creeps under the load.

Remedy:

Check the **OR** fit or its locking tightness.

Case # 2

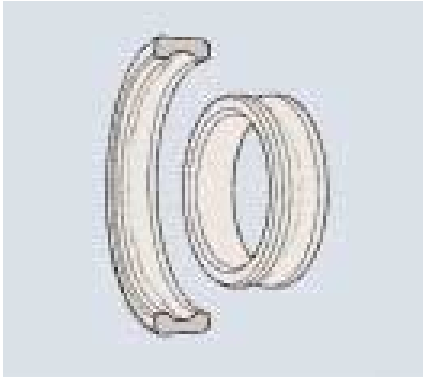

| | |
|-----------|-------------------------------------|
| OR | Rotates |
| IR | Stationary but creeps under load |
| Fr | Stationary in relation to the shaft |
| Fa | None |
| a | None |

Identification:

Ball path can be seen all around the circumference of both raceways.

Causes:

Abnormal rotation of the **IR** in relation to the shaft. Presence of marks inside the bore, along with partial disappearance of grinding lines due to the bore buffing, is characteristic of **IR** sliding.

Remedy:

Check the **IR** fit on the shaft or the locking tightness of the adapter.

Case # 3

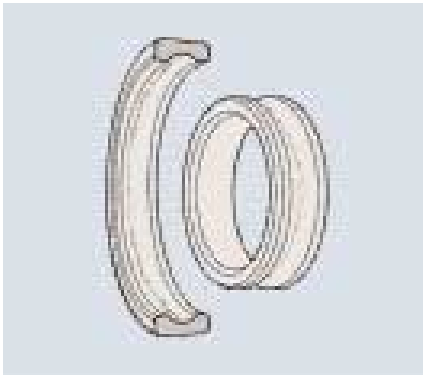

| | |
|-----------|--|
| OR | Stationary |
| IR | Rotates - Excessive press fit on the shaft |
| Fr | Extra load caused by an over stress of the IR |
| Fa | None |
| a | None |

Identification:

Ball path can be seen all around the circumference of both raceways.

Causes:

Excessive press fit either of the **OR** within its housing or the **IR** onto the shaft. The internal clearance is eliminated and stresses are added to the normal load.

Remedy:

Check the fit of the ring abnormally stressed. Increase the bearing internal clearance.

Case # 4

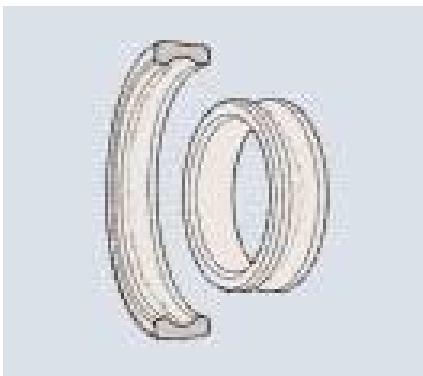

| | |
|-----------|---|
| OR | Rotates - Excessive press fit in the housing |
| IR | Stationary |
| Fr | Extra load cause by an over stress of the OR |
| Fa | None |
| a | None |

Identification:

Ball path can be seen all around the circumference of both raceways.

Causes:

Excessive press fit either of the **OR** within its housing or the **IR** onto the shaft. The internal clearance is eliminated and stresses are added to the normal load.

Remedy:

Check the fit of the ring abnormally stressed. Increase the bearing internal clearance.

Analysis of actual cases

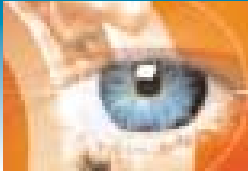

Consequences of improper location of load areas

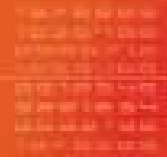

Case # 5

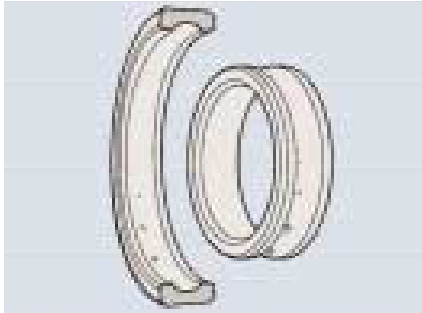

| | |
|-----------|--|
| OR | Stationary in relation to the IR |
| IR | Stationary in relation to the OR |
| Fr | Stationary in relation to the IR or OR |
| Fa | None |
| a | None |

Identification:

Contact areas are located on an arc of circle slightly smaller than a half circumference.

Causes:

Vibrations occurring in a non-operating bearing.

Remedy:

Re. Page 18 (Chap. Vibrations)

Case # 6

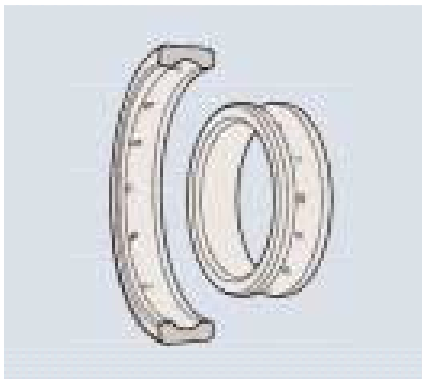

| | |
|-----------|---|
| OR | Stationary in relation to the IR |
| IR | Stationary in relation to the OR |
| Fr | Rotates in relation to the OR or IR |
| Fa | None |
| a | None |

Identification:

Equidistant contact areas are spaced corresponding to the ball spacing. They can be seen in the bottom of raceways and all around the circumference of **OR** and **IR** raceways.

Causes:

Vibrations on the bearing. Under vibrations, the cage might slightly rotate when operating. Sequence of equidistant contact areas can be seen.

Remedy:

Eliminate causes of vibrations. Use a proper lubricant.

Case # 7

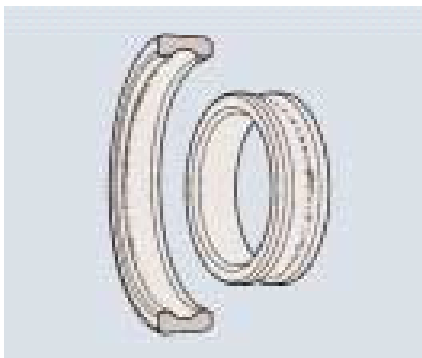

| | |
|-----------|---|
| OR | Stationary - Rotates |
| IR | Rotates - Stationary |
| Fr | None or hardly any in relation to Fa |
| Fa | Continuous |
| a | None |

Identification:

Ball paths all around the **OR** and **IR** circumferences are abnormally offset: On **IR**: towards the face subjected to **Fa**. On **OR**: towards the face opposite to **Fa**.

Causes:

Abnormal axial load.

Remedy:

Check whether **Fa** is not too high.

Case # 8

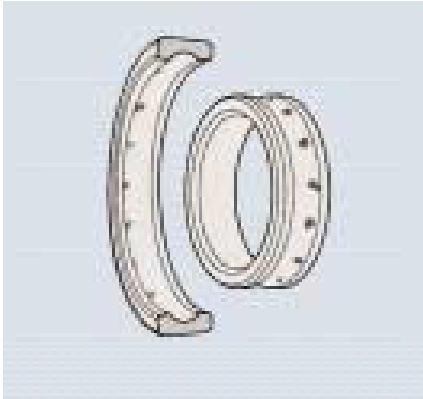

| | |
|-----------|---|
| OR | Stationary in relation to the IR |
| IR | Stationary in relation to the OR |
| Fr | None |
| Fa | Vibrating load |
| a | None |

Identification:

Ball-raceway contact areas are regularly spaced, all around the **OR** and **IR** circumference, corresponding to the ball spacing. These contacts areas are offset: On **IR**: towards the face subjected to **Fa**. On **OR**: towards the face opposite to **Fa**.

Causes:

Vibrating thrust load.

Remedy:

Check if vibrating load is normal. Use proper lubricant.

Case # 9

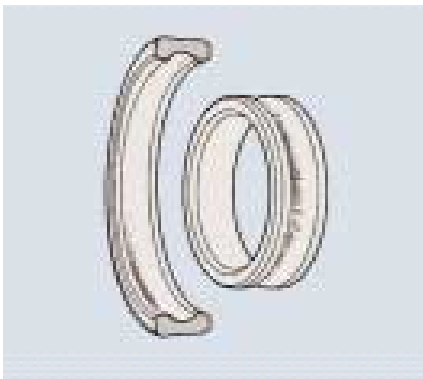

| | |
|-----------|---|
| OR | Stationary |
| IR | Rotates in relation to the OR |
| Fr | Stationary in relation to the OR |
| Fa | None |
| a | Value corresponding to the elimination of clearance |

Identification:

Operating ball path on the **OR** is skewed in relation to the raceway centerline. There are 2 load path areas, diametrically opposed (only one area if the bearing still has an internal clearance). The whole circumference of the **IR** is affected by the ball path; the ball path width corresponds to the space between the operating limits of the **OR** raceway, as determined by **a**.

Causes:

Misalignment between the **OR** housing and the shaft.

Remedy:

Align the housing. Check the squareness of the shoulders in relation to the housing bore centerline.

Case # 10

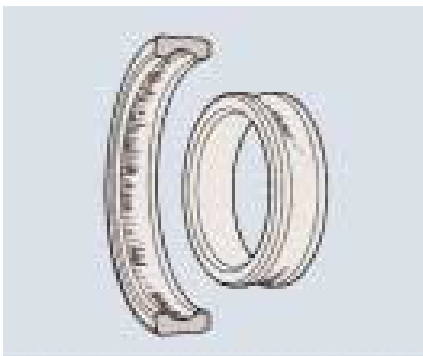

| | |
|-----------|---|
| OR | Rotates in relation to the IR |
| IR | Stationary |
| Fr | Stationary in relation to the IR |
| Fa | None |
| a | Value corresponding to the elimination of clearance |

Identification:

The ball path of the **OR** is wide and can be seen all around the circumference when internal clearance is eliminated. On the **IR**, two half ball-paths are diametrically opposed and are skewed in relation to the raceway centerline.

Causes:

Housing and shaft misalignment.

Remedy:

Check the alignment and the squareness of the shaft shoulder.

Europe

FRANCE - EUROPE

SNR Paris 40, rue Jean Bleuzen
B.P. 49
92174 Vanves Cedex
Tél. 01 40 93 66 00
Fax. 01 40 93 66 10

SNR Logistique 9, avenue Léon Harmel
92160 Antony
Tél. 01 46 11 66 50
Fax. 01 46 11 66 66

SNR Bordeaux 1, rue du Golf - B.P. 173
33708 Merignac Cedex
Tél. 05 56 34 69 80
Fax. 05 56 34 69 81

SNR Lyon Europe* Le Florentin - 71, chemin
du Moulin Carron - B.P. 8
69570 Dardilly
Tél. 04 78 66 68 00
Fax. 04 78 66 68 20

SNR Nancy Europe* 3, allée Forêt de la Reine
Parc technologique Brabois
54500 Vandœuvre
Tél. 03 83 44 64 00
Fax. 03 83 44 02 31

DEUTSCHLAND

SNR WÄLZLAGER GMBH
40472 Düsseldorf
Wahlerstraße 6
40437 Düsseldorf
Postfach 33 04 10
www.snr.de
Tél. (0211) 6 58 06-0
Fax. (0211) 6 58 88 86

33719 Bielefeld Friedrich-Hagemann-Str.66
33701 Bielefeld
Postfach 17 01 45
Tél. (0521) 9 24 00-0
Fax. (0521) 9 24 00 90

70597 Stuttgart Tränkestraße 7
70574 Stuttgart
Postfach 70 04 16
Tél. (0711) 9 00 64-0
Fax. (0711) 9 00 64 99

ITALIA

SNR Italia
Milano Via Keplero, 5
20019 Settimo
Milanese (MI)
Tél. (02) 33 55 21
Fax (02) 33 50 06 56

Bologna Via E.Zago, 2/2
40128 Bologna
Tél. (051) 36 79 46
(051) 36 29 78
Fax (051) 36 85 38

ESPAÑA - PORTUGAL

SNR Rodamientos Ibérica S.A.
Madrid C/ Llanos de Jerez, 22
Poligono Industrial
28820 Coslada
Tél. 91 671 89 13
Fax. 91 673 65 48

*EUROPE (Subsidiaries excepted)
SNR Nancy - Europe : Benelux - Suisse - Autriche - U.K.
SNR Lyon - Europe : Other Countries Fax. 04 78 66 68 21

Amériques / Americas

USA

SNR Bearings USA
Atlanta 4600 K Highlands Pkwy
Smyrna, G.A. 30082
www.snrbearings.com
Tél. (770) 435-2818
(800) 232-1717
Fax. (800) 742-5215

AMERICA LATINA

SNR Argentina
Buenos-Aires Viamonte 1145 - Piso 11
1053 Buenos-Aires
Tél. (54) 11-4 372-1272
Fax. (54) 11-4 372-0088

Autres pays / Other countries

SNR Intermondial (Overseas)

Anney 18, rue du Val-Vert
74600 Seynod
France
Tél. (33) 4 50 65 96 00/01/02
Fax. (33) 4 50 65 96 15

MAROC

SNR Maroc
Casablanca 73, Bd Moulay Slimane
Ain Sebaâ CASABLANCA
B.P. 15873 CASA-PRINCIPAL
e-mail : info@snr.ma
Tél. (212) 22 66 76 80
Fax. (212) 22 66 51 66



Siège social : Rue des Usines - 74000 Anney - FRANCE

RCS Anney B 325821072 - Code NAF 291H

<http://www.snr.fr>